



Item	Page #
Design Casters .....	2-5
PolyTech Casters .....	6-9
Bi-Brake Casters .....	10-15
Medical Equipment Casters - Stainless Steel .....	16-18
Medical Equipment Casters - Next Generation Nylon .....	19-31
Medical Equipment Casters - Nylon Plus Stainless .....	32-39
Institutional Casters .....	40-43
Hospital Casters .....	44-77
Wheel Bearings .....	78
Swivel Bearings .....	79
Fittings .....	81

**Additional Stainless Steel Hospital Casters:**

**SEE CATEGORY 02**

02C/SS Features .....

02C/SS Stem Type, Plate Type, Hole Type .....

Acorn™ can supply any size and type caster rig with any type wheel with proper size precision ball bearings (see Wheel Section). Call, fax or e-mail for application assistance, or visit our website to view our complete catalog in PDF format.

Visit our Web site for new products  
[www.acornindprod.com](http://www.acornindprod.com)

**BI-BRAKE CASTERS**

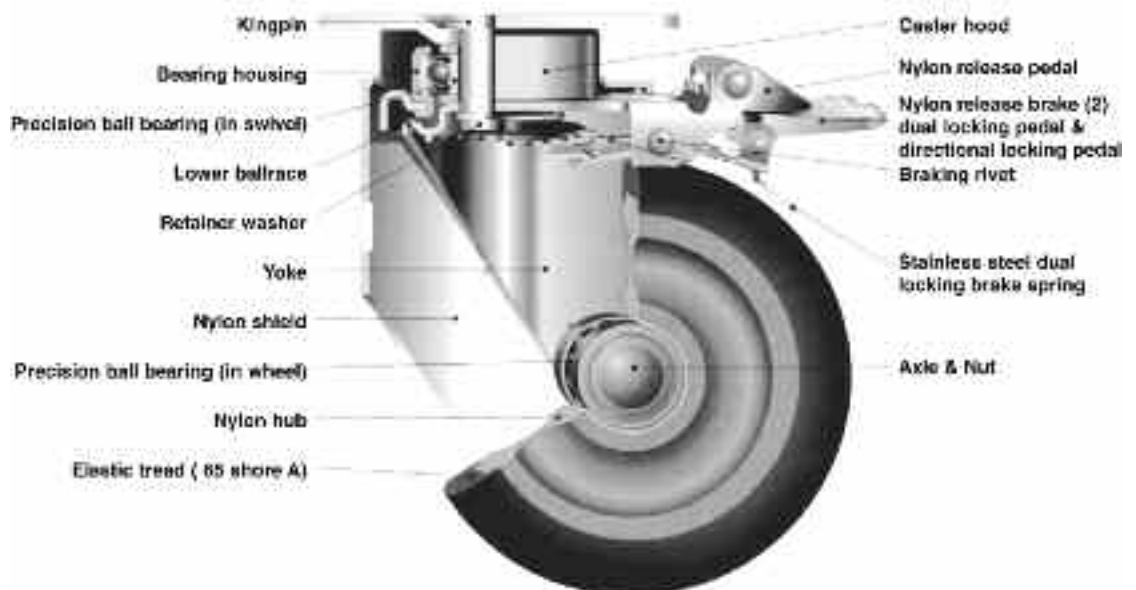

**DC Design Casters** are beautifully designed, and geared towards economical means.

It is especially suitable for general institution applications. And with ABS cover, it can be kept clean easily and adds to the environment a more conspicuous hygienic and aesthetic value.



When carts/trolleys demand quality and a human touch, our DC would be the best choice.

**Application:**

General institution applications; medical diagnostic machines.

**Size Available:**

100x25, 125x32mm

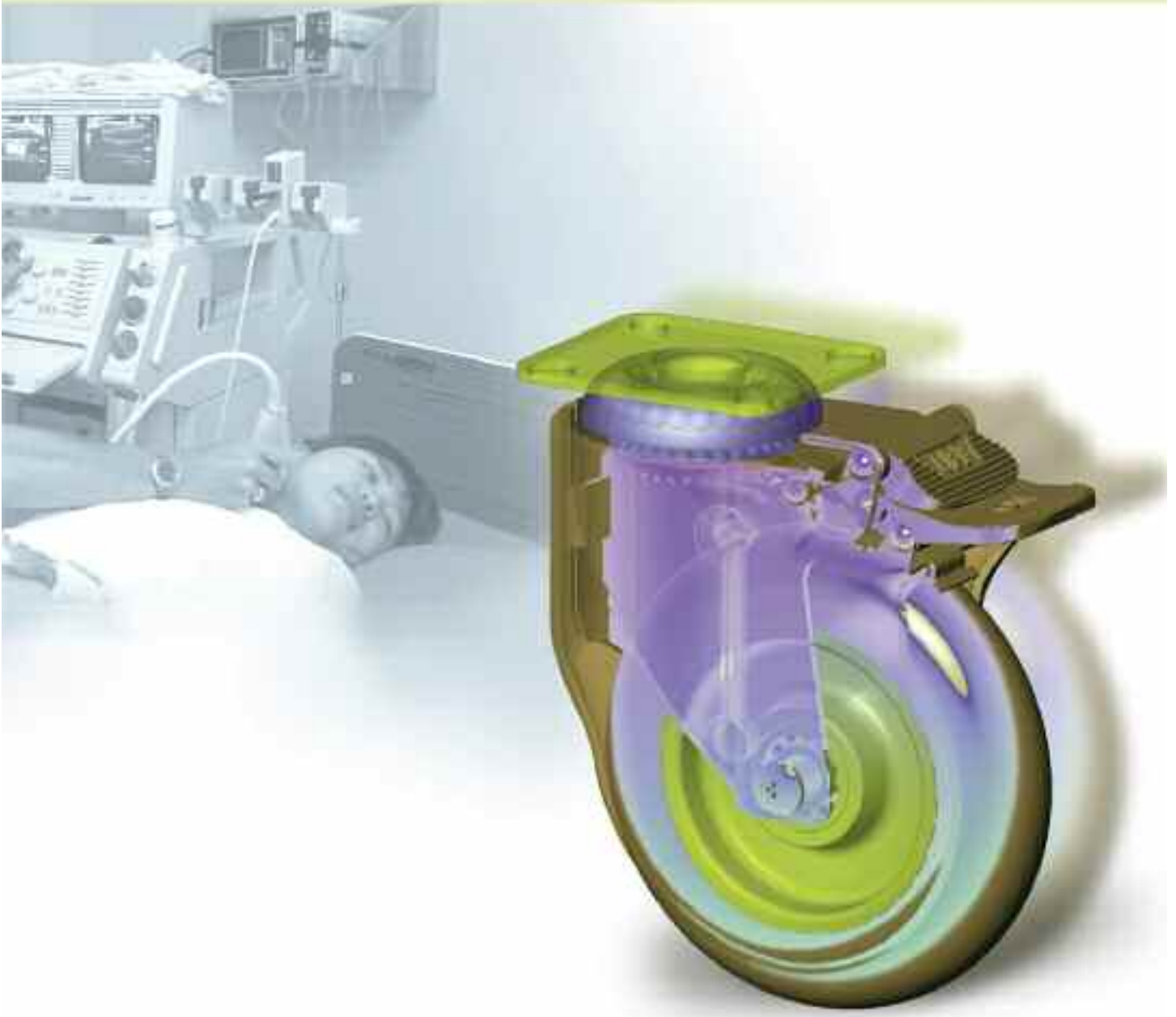

Pressed steel, zinc-chromatized double ballrace swivel yoke, aesthetic streamlined ABS covers



**TLB Total locking brake**  
Total Lock system locks both swivel head and wheel simultaneously for secure parking. Integrated ON/OFF Nylon brake pedals for easy and quiet operation.



**DLB Directional locking brake**  
Directional Lock permits free wheel rotation while swivel head remains locked, an easy way to keep equipment traveling straight. Integrated ON/OFF Nylon brake pedals for easy and quiet operation. Release pedal in green color.

## P Top Plate Fitting

**TPR Wheel** Plastic hub, grey color thermoplastic rubber tire

Roller type	100	125	150	175	200	225	250	275	300	325	Code	
<b>TLB</b> Total locking brake	100	32		36 x 70	75 x 52 / 72 x 43	3.0	33.0	136.0	60		DC195E1/WV12	
	100	32		77 x 67	81.5 x 52 / 56 x 48	3.5	33.0	136.0	60		DC196D2/WV12	
	125	32		36 x 70	75 x 52 / 72 x 43	3.0	33.0	161.0	103		DC125E1/WV50	
	125	32		77 x 67	81.5 x 52 / 56 x 48	3.5	33.0	161.0	103		DC126D2/WV50	
<b>DLB</b> Dir. locking brake	125	32		36 x 70	75 x 52 / 72 x 43	3.0	33.0	161.0	103		DC125DE1/WV50U	
	125	32		77 x 67	81.5 x 52 / 56 x 48	3.5	33.0	161.0	103		DC126DF2/WV50U	
	150	32		36 x 70	75 x 52 / 72 x 43	3.0	33.0	161.0	103		DC150DE1/WV50U	
	150	32		77 x 67	81.5 x 52 / 56 x 48	3.5	33.0	161.0	103		DC150DF2/WV50U	
Non-brake Free swivel	125	32		36 x 70	75 x 52 / 72 x 43	3.0	33.0	161.0	103		DC125F1/WV50	
	125	32		77 x 67	81.5 x 52 / 56 x 48	3.5	33.0	161.0	103		DC126F2/WV50	
	150	32		36 x 70	75 x 52 / 72 x 43	3.0	33.0	161.0	103		DC150F1/WV50	
	150	32		77 x 67	81.5 x 52 / 56 x 48	3.5	33.0	161.0	103		DC150F2/WV50	

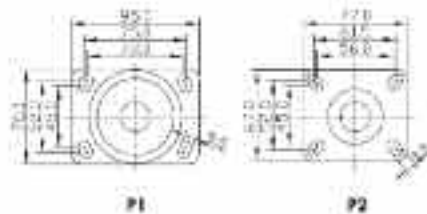











## P Top Plate Fitting

### TPU Wheel Plastic hub, gray color polyurethane tire

Stroke type	mm	mm	mm	mm	mm	mm	mm	mm	kg	Code	
 Lock locking stroke	125	32		95 x 70	75 x 52 / 72 x 45	8.0	39.0	101.0	100	DC125AP1W03U	
	125	32		77 x 67	61.5 x 52 / 56 x 45	8.0	39.0	101.0	100	DC125AP2W03U	
	125	32		95 x 70	75 x 52 / 72 x 45	8.0	39.0	101.0	100	DC125AP1W03U	
	125	32		77 x 67	61.5 x 52 / 56 x 45	8.0	39.0	101.0	100	DC125AP2W03U	
 Dr. locking stroke	125	32		95 x 70	75 x 52 / 72 x 45	8.0	39.0	101.0	100	DC125DP1W03U	
	125	32		77 x 67	61.5 x 52 / 56 x 45	8.0	39.0	101.0	100	DC125DP2W03U	
	125	32		95 x 70	75 x 52 / 72 x 45	8.0	39.0	101.0	100	DC125DP1W03U	
	125	32		77 x 67	61.5 x 52 / 56 x 45	8.0	39.0	101.0	100	DC125DP2W03U	
Non-lock Free stroke	125	32		95 x 70	75 x 52 / 72 x 45	8.0	39.0	101.0	100	DC125PW03U	
	125	32		77 x 67	61.5 x 52 / 56 x 45	8.0	39.0	101.0	100	DC125PW03U	
	125	32		95 x 70	75 x 52 / 72 x 45	8.0	39.0	101.0	100	DC125PW03U	
	125	32		77 x 67	61.5 x 52 / 56 x 45	8.0	39.0	101.0	100	DC125PW03U	

### ARB Wheel Al alloy hub, gray color high elastic rubber tire

Stroke type	mm	mm	mm	mm	mm	mm	mm	mm	kg	Code	
 Lock locking stroke	125	32		95 x 70	75 x 52 / 72 x 45	8.0	39.0	101.0	100	DC125AP1W02BU	
	125	32		77 x 67	61.5 x 52 / 56 x 45	8.0	39.0	101.0	100	DC125AP2W02BU	
 Dr. locking stroke	125	32		95 x 70	75 x 52 / 72 x 45	8.0	39.0	101.0	100	DC125DP1W02BU	
	125	32		77 x 67	61.5 x 52 / 56 x 45	8.0	39.0	101.0	100	DC125DP2W02BU	
Non-lock Free stroke	125	32		95 x 70	75 x 52 / 72 x 45	8.0	39.0	101.0	100	DC125PW02BU	
	125	32		77 x 67	61.5 x 52 / 56 x 45	8.0	39.0	101.0	100	DC125PW02BU	